

## Description

### JMT N And P-channel Enhancement Mode Power MOSFET

#### Features

- N-channel: 30V, 10A  
 $R_{DS(ON)} < 21m\Omega @ V_{GS} = 10V$   
 $R_{DS(ON)} < 30m\Omega @ V_{GS} = 4.5V$
- P-channel: -30V, -8A  
 $R_{DS(ON)} < 27m\Omega @ V_{GS} = -10V$   
 $R_{DS(ON)} < 38m\Omega @ V_{GS} = -4.5V$
- Excellent Gate Charge x  $R_{DS(ON)}$  Product(FOM)
- Very Low On-resistance  $R_{DS(ON)}$
- Fast Switching Speed

#### Applications

- Battery Protection
- Load Switch
- Power Management



**100% UIS TESTED!**  
**100% ΔVds TESTED!**

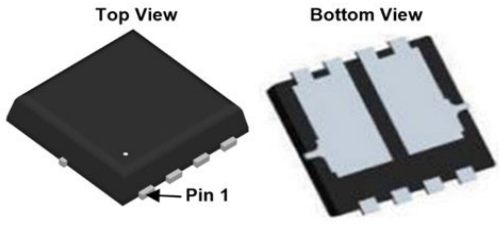

PDFN3x3-8L-D

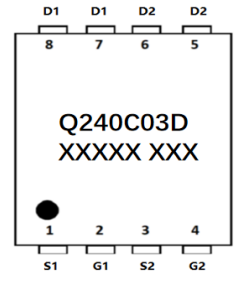

Marking and Pin Assignment

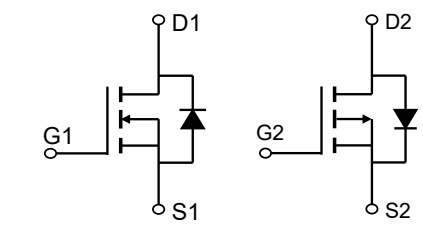

Schematic Diagram

### Package Marking and Ordering Information

Device Marking	Device	Outline	Package	Reel Size	Reel(pcs)	Per Carton (pcs)
Q240C03D	JMTQ240C03D	TAPING	PDFN3x3-8L-D	13"	5000	50000

### Absolute Maximum Ratings (@ $T_C = 25^\circ C$ unless otherwise specified)

Symbol	Parameter	Value-N-channel	Value-P-channel	Units
$V_{DS}$	Drain-to-Source Voltage	30	-30	V
$V_{GS}$	Gate-to-Source Voltage	±20		V
$I_D$	Continuous Drain Current	$T_C = 25^\circ C$	10	-8
		$T_C = 100^\circ C$	6.3	-5.1
$I_{DM}$	Pulsed Drain Current <sup>(1)</sup>	40	-32	A
$E_{AS}$	Single Pulsed Avalanche Energy <sup>(2)</sup>	12	20	mJ
$P_D$	Power Dissipation	$T_C = 25^\circ C$		15
$R_{\theta JA}$	Thermal Resistance, Junction to Ambient <sup>(3)</sup>			66
$R_{\theta JC}$	Thermal Resistance, Junction to Case			8.3
$T_J, T_{STG}$	Junction & Storage Temperature Range			-55 to 150



## N-channel Electrical Characteristics (T<sub>J</sub> = 25°C unless otherwise specified)

Symbol	Parameter	Conditions	Min.	Typ.	Max.	Unit
<b>Off Characteristics</b>						
V <sub>(BR)DSS</sub>	Drain-Source Breakdown Voltage	I <sub>D</sub> = 250μA, V <sub>GS</sub> = 0V	30	-	-	V
I <sub>DSS</sub>	Zero Gate Voltage Drain Current	V <sub>DS</sub> = 30V, V <sub>GS</sub> = 0V	-	-	1.0	μA
I <sub>GSS</sub>	Gate-Body Leakage Current	V <sub>DS</sub> = 0V, V <sub>GS</sub> = ±20V	-	-	±100	nA
<b>On Characteristics</b>						
V <sub>GS(th)</sub>	Gate Threshold Voltage	V <sub>DS</sub> = V <sub>GS</sub> , I <sub>D</sub> = 250μA	1.0	1.7	2.5	V
R <sub>DS(ON)</sub>	Static Drain-Source ON-Resistance <sup>(4)</sup>	V <sub>GS</sub> = 10V, I <sub>D</sub> = 5A	-	16	21	mΩ
		V <sub>GS</sub> = 4.5V, I <sub>D</sub> = 3A	-	23	30	mΩ
<b>Dynamic Characteristics</b>						
C <sub>iss</sub>	Input Capacitance	V <sub>GS</sub> = 0V, V <sub>DS</sub> = 15V, f = 1MHz	-	481	-	pF
C <sub>oss</sub>	Output Capacitance		-	69	-	pF
C <sub>rss</sub>	Reverse Transfer Capacitance		-	53	-	pF
Q <sub>g</sub>	Total Gate Charge	V <sub>GS</sub> = 0 to 10V V <sub>DD</sub> = 15V, I <sub>D</sub> = 3A	-	10	-	nC
Q <sub>gs</sub>	Gate Source Charge		-	2	-	nC
Q <sub>gd</sub>	Gate Drain("Miller") Charge		-	2	-	nC
<b>Switching Characteristics</b>						
t <sub>d(on)</sub>	Turn-On DelayTime	V <sub>GS</sub> = 10V, V <sub>DD</sub> = 15V I <sub>D</sub> = 3A, R <sub>GEN</sub> = 3Ω	-	4	-	ns
t <sub>r</sub>	Turn-On Rise Time		-	6	-	ns
t <sub>d(off)</sub>	Turn-Off DelayTime		-	12	-	ns
t <sub>f</sub>	Turn-Off Fall Time		-	3	-	ns
<b>Drain-Source Diode Characteristics and Max Ratings</b>						
I <sub>S</sub>	Maximum Continuous Drain to Source Diode Forward Current		-	-	10	A
I <sub>SM</sub>	Maximum Pulsed Drain to Source Diode Forward Current		-	-	40	A
V <sub>SD</sub>	Drain to Source Diode Forward Voltage	V <sub>GS</sub> = 0V, I <sub>S</sub> = 10A	-	-	1.2	V
t <sub>rr</sub>	Body Diode Reverse Recovery Time	I <sub>F</sub> = 3A, di/dt = 100A/μs	-	8	-	ns
Q <sub>rr</sub>	Body Diode Reverse Recovery Charge		-	2	-	nC



## P-channel Electrical Characteristics (T<sub>J</sub> = 25°C unless otherwise specified)

Symbol	Parameter	Conditions	Min.	Typ.	Max.	Unit
<b>Off Characteristics</b>						
V <sub>(BR)DSS</sub>	Drain-Source Breakdown Voltage	I <sub>D</sub> = -250μA, V <sub>GS</sub> = 0V	-30	-	-	V
I <sub>DSS</sub>	Zero Gate Voltage Drain Current	V <sub>DS</sub> = -30V, V <sub>GS</sub> = 0V	-	-	-1.0	μA
I <sub>GSS</sub>	Gate-Body Leakage Current	V <sub>DS</sub> = 0V, V <sub>GS</sub> = ±20V	-	-	±100	nA
<b>On Characteristics</b>						
V <sub>GS(th)</sub>	Gate Threshold Voltage	V <sub>DS</sub> = V <sub>GS</sub> , I <sub>D</sub> = -250μA	-1	-1.7	-2.5	V
R <sub>DS(ON)</sub>	Static Drain-Source ON-Resistance <sup>(4)</sup>	V <sub>GS</sub> = -10V, I <sub>D</sub> = -7A	-	21	27	mΩ
		V <sub>GS</sub> = -4.5V, I <sub>D</sub> = -4A	-	29	38	mΩ
<b>Dynamic Characteristics</b>						
C <sub>iss</sub>	Input Capacitance	V <sub>GS</sub> = 0V, V <sub>DS</sub> = -15V, f = 1MHz	-	859	-	pF
C <sub>oss</sub>	Output Capacitance		-	110	-	pF
C <sub>riss</sub>	Reverse Transfer Capacitance		-	84	-	pF
Q <sub>g</sub>	Total Gate Charge	V <sub>GS</sub> = 0 to -10V V <sub>DD</sub> = -15V, I <sub>D</sub> = -3A	-	16	-	nC
Q <sub>gs</sub>	Gate Source Charge		-	3	-	nC
Q <sub>gd</sub>	Gate Drain("Miller") Charge		-	3	-	nC
<b>Switching Characteristics</b>						
t <sub>d(on)</sub>	Turn-On DelayTime	V <sub>GS</sub> = -10V, V <sub>DD</sub> = -15V I <sub>D</sub> = -3A, R <sub>GEN</sub> = 3Ω	-	4	-	ns
t <sub>r</sub>	Turn-On Rise Time		-	2	-	ns
t <sub>d(off)</sub>	Turn-Off DelayTime		-	38	-	ns
t <sub>f</sub>	Turn-Off Fall Time		-	22	-	ns
<b>Drain-Source Diode Characteristics and Max Ratings</b>						
I <sub>S</sub>	Maximum Continuous Drain to Source Diode Forward Current		-	-	-8	A
I <sub>SM</sub>	Maximum Pulsed Drain to Source Diode Forward Current		-	-	-32	A
V <sub>SD</sub>	Drain to Source Diode Forward Voltage	V <sub>GS</sub> = 0V, I <sub>S</sub> = -8A	-	-	-1.2	V
t <sub>rr</sub>	Body Diode Reverse Recovery Time	I <sub>F</sub> = -3A, di/dt = 100A/μs	-	10	-	ns
Q <sub>rr</sub>	Body Diode Reverse Recovery Charge		-	3	-	nC

- Notes:
1. Repetitive Rating: Pulse Width Limited by Maximum Junction Temperature.
  2. E<sub>AS</sub> condition: Starting T<sub>J</sub> = 25°C, V<sub>DD</sub> = 20V, V<sub>G</sub> = 10V, R<sub>G</sub> = 25ohm, L = 0.5mH, I<sub>AS</sub> = 7A  
Starting T<sub>J</sub> = 25°C, V<sub>DD</sub> = -20V, V<sub>G</sub> = -10V, R<sub>G</sub> = 25ohm, L = 0.5mH, I<sub>AS</sub> = -9A
  3. R<sub>θJA</sub> is measured with the device mounted on a 1inch<sup>2</sup> pad of 2oz copper FR4 PCB
  4. Pulse Test: Pulse Width ≤ 300μs, Duty Cycle ≤ 0.5%.

## Typical Performance Characteristics-N

Figure 1: Output Characteristics

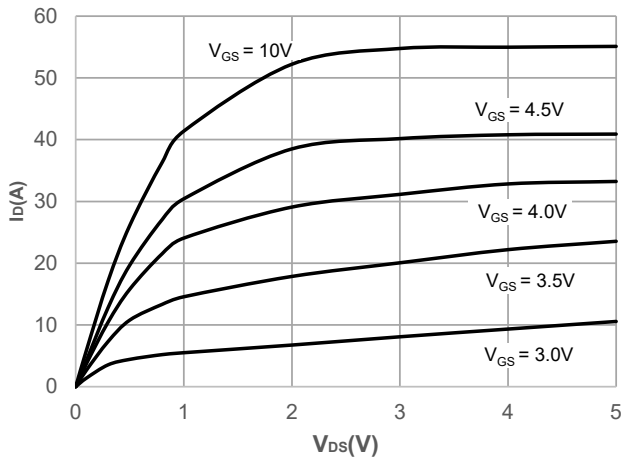

Figure 2: Typical Transfer Characteristics

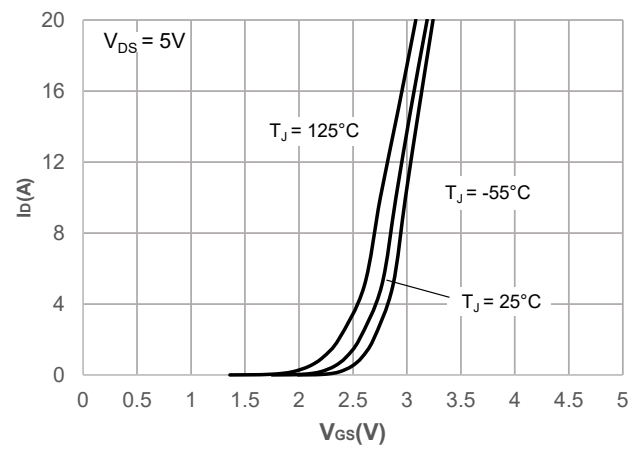

Figure 3: On-resistance vs. Drain Current

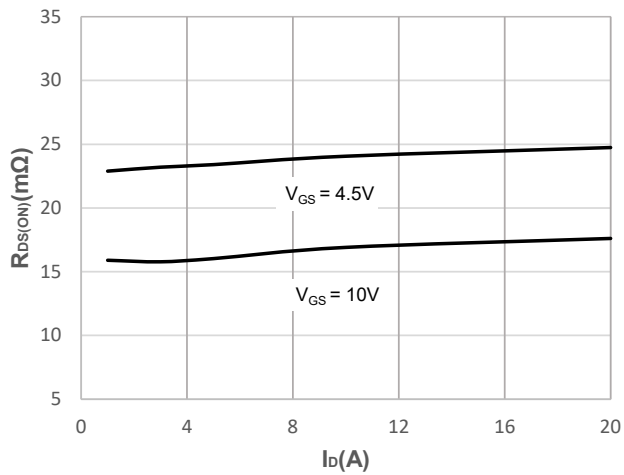

Figure 4: Body Diode Characteristics

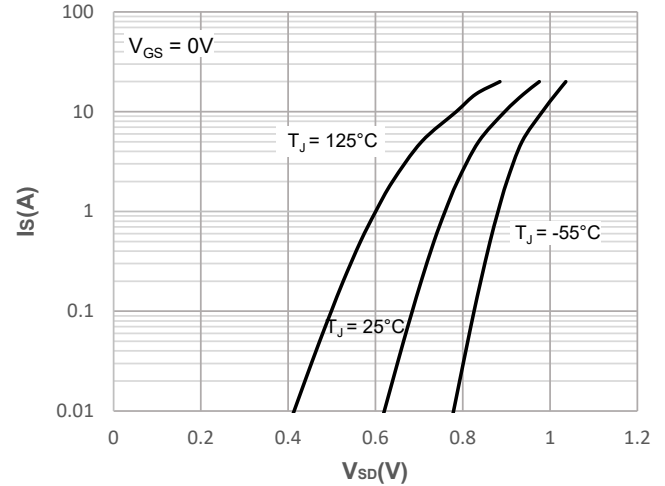

Figure 5: Gate Charge Characteristics

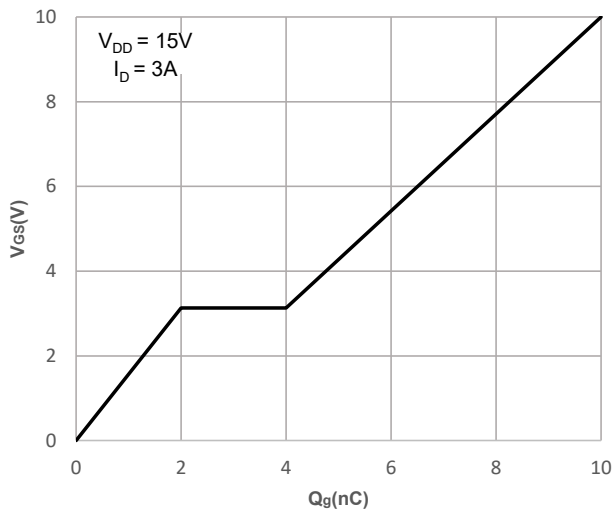
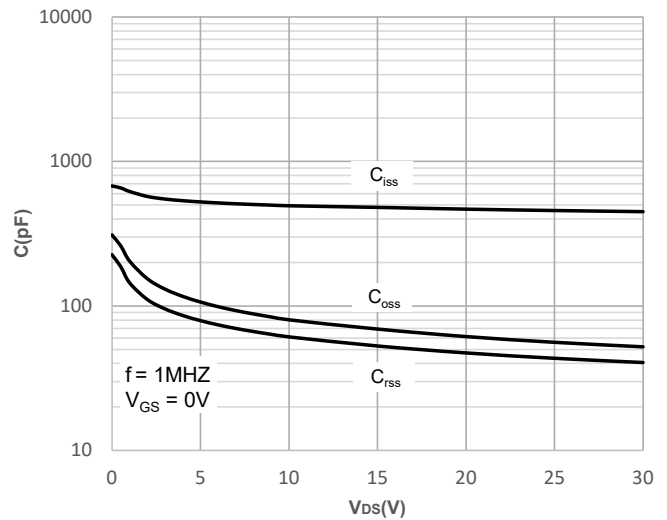

Figure 6: Capacitance Characteristics



## Typical Performance Characteristics-N

Figure 7: Normalized Breakdown voltage vs. Junction Temperature

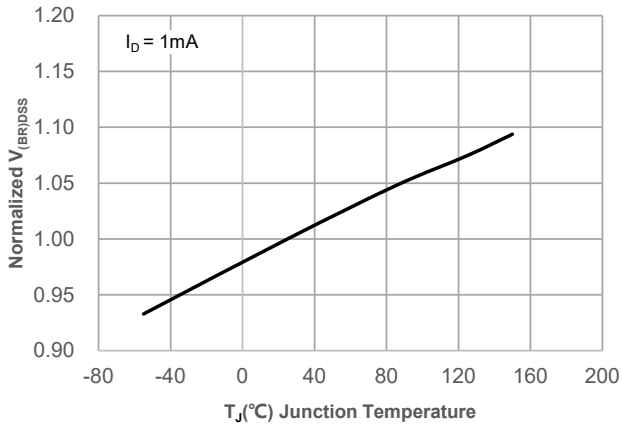

Figure 8: Normalized on Resistance vs. Junction Temperature

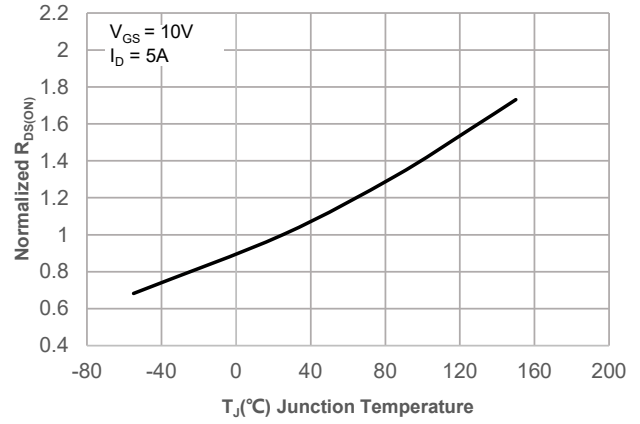

Figure 9: Maximum Safe Operating Area

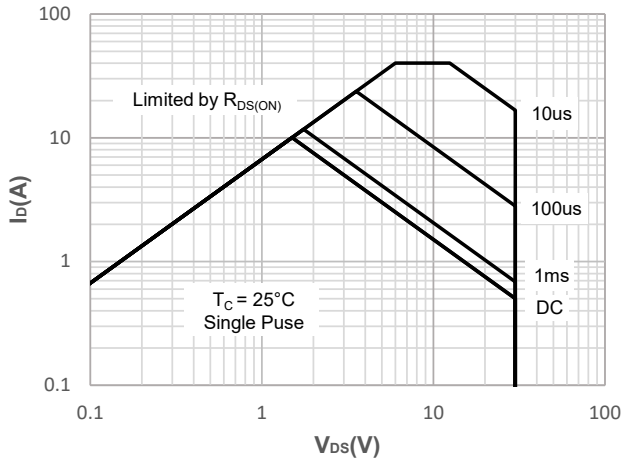

Figure 10: Maximum Continuous Driant Current vs. Case Temperature

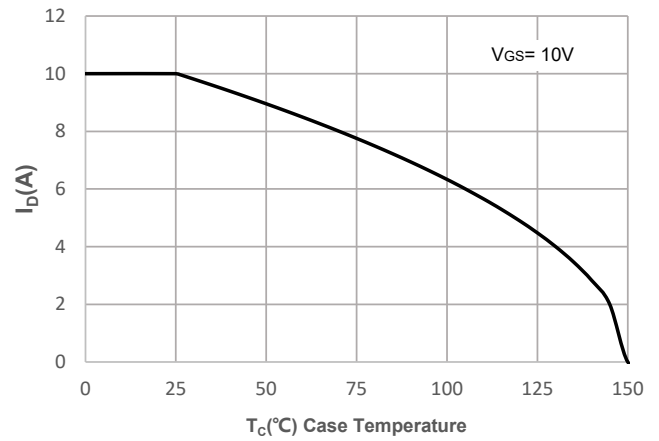

Figure 11: Normalized Maximum Transient Thermal Impedance

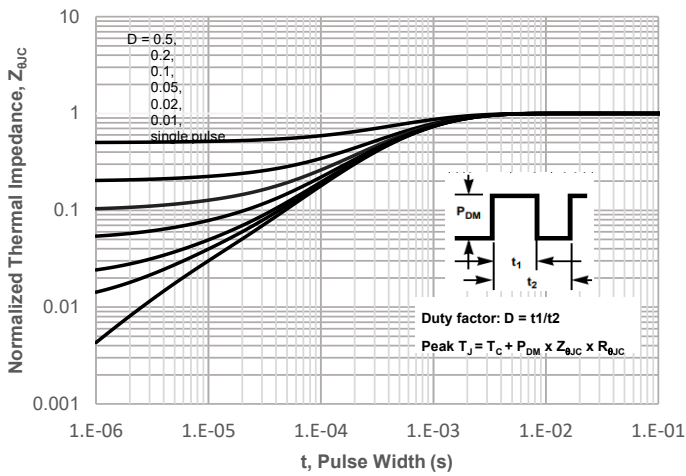
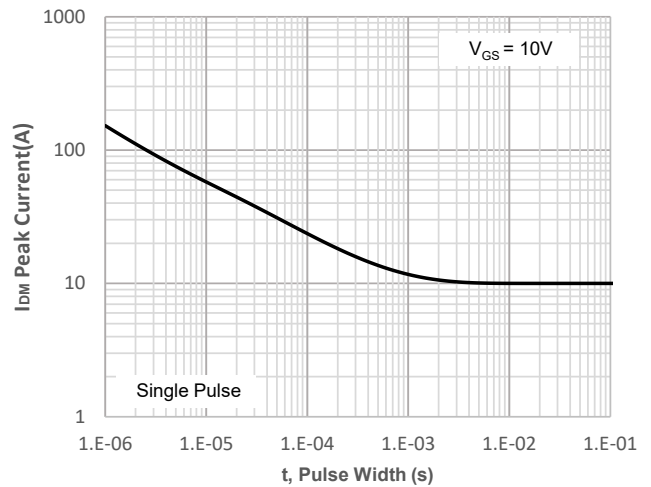
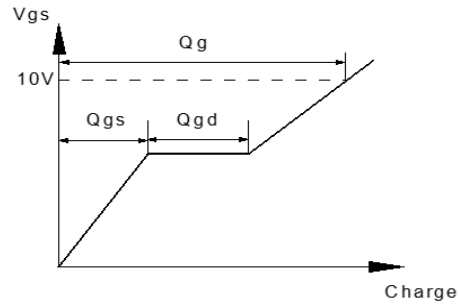
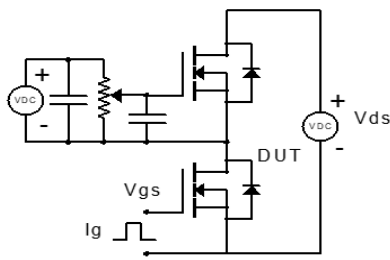

Figure 12: Peak Current Capacity



## Test Circuit-N



**Figure 1: Gate Charge Test Circuit & Waveform**

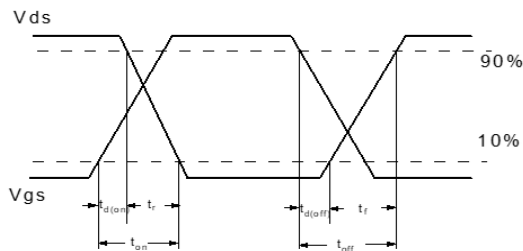
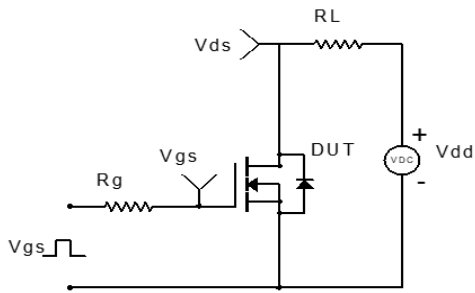

**Figure 2: Resistive Switching Test Circuit & Waveform**

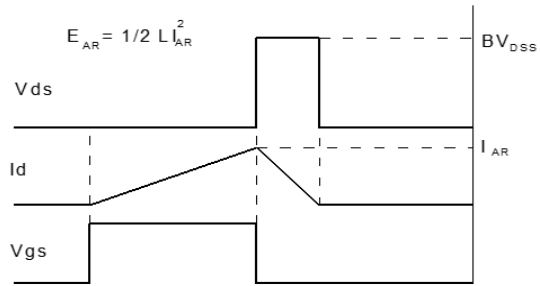
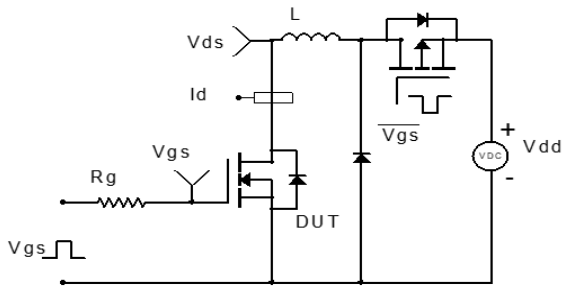

**Figure 3: Unclamped Inductive Switching Test Circuit & Waveform**

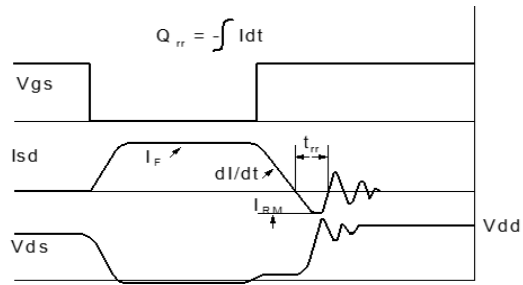
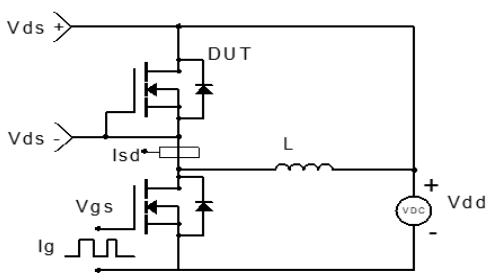

**Figure 4: Diode Recovery Test Circuit & Waveform**

## Typical Performance Characteristics-P

Figure 1: Output Characteristics

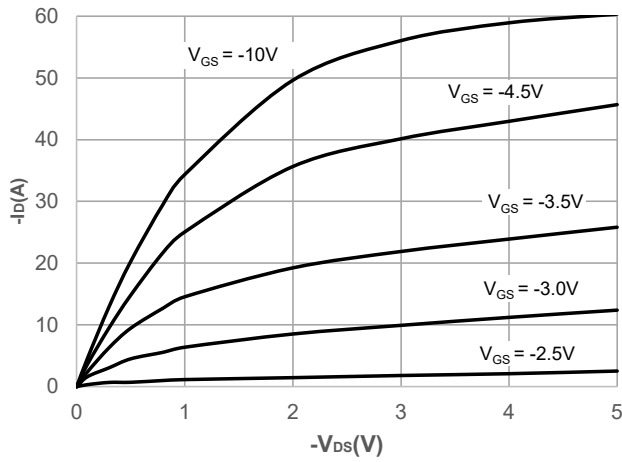

Figure 2: Typical Transfer Characteristics

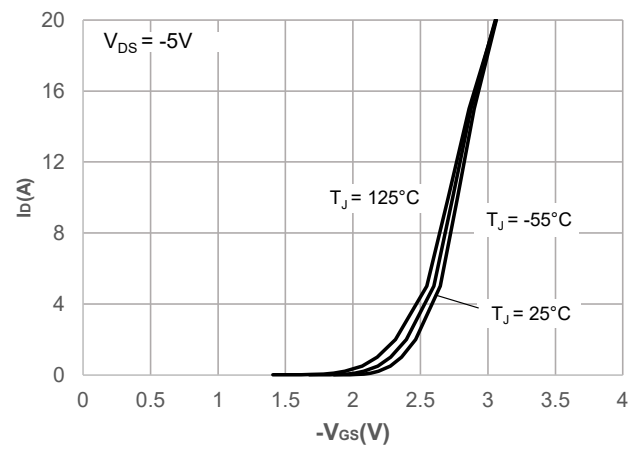

Figure 3: On-resistance vs. Drain Current

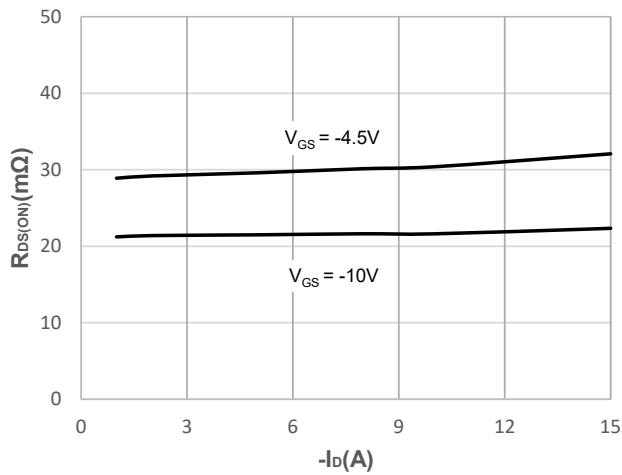

Figure 4: Body Diode Characteristics

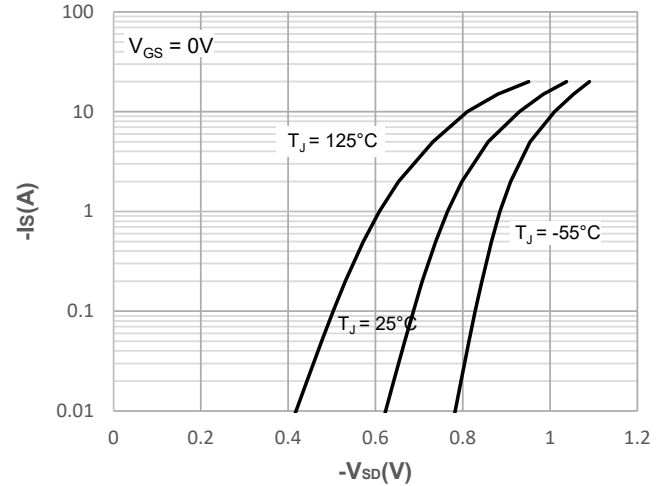

Figure 5: Gate Charge Characteristics

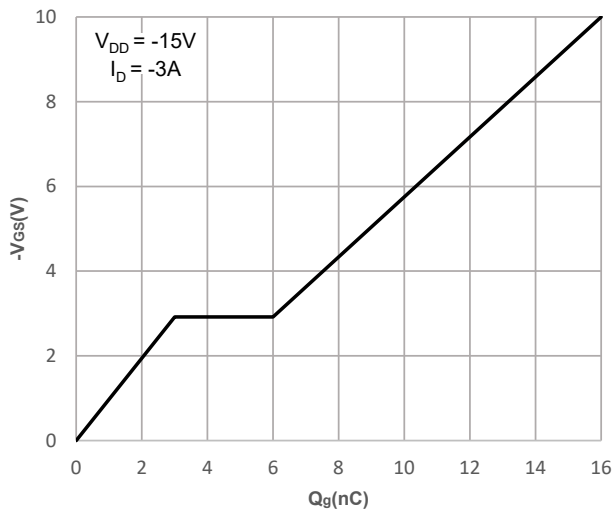
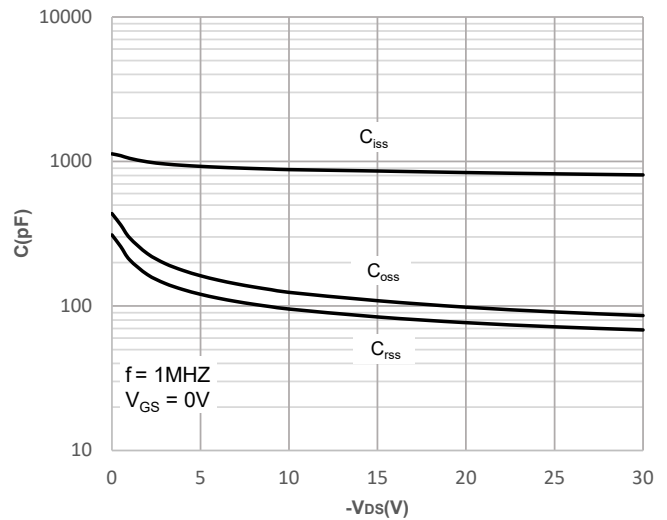

Figure 6: Capacitance Characteristics



## Typical Performance Characteristics-P

Figure 7: Normalized Breakdown voltage vs. Junction Temperature

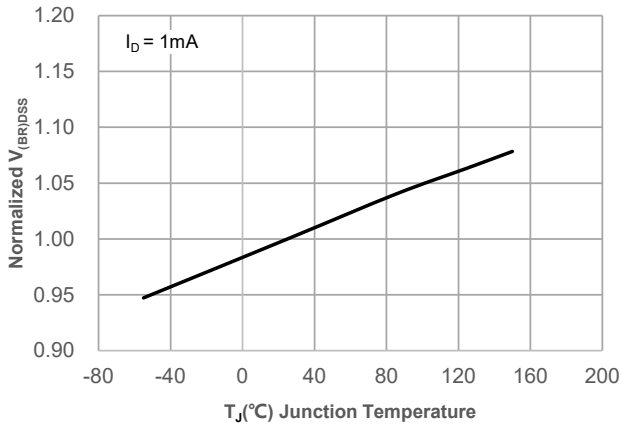

Figure 8: Normalized on Resistance vs. Junction Temperature

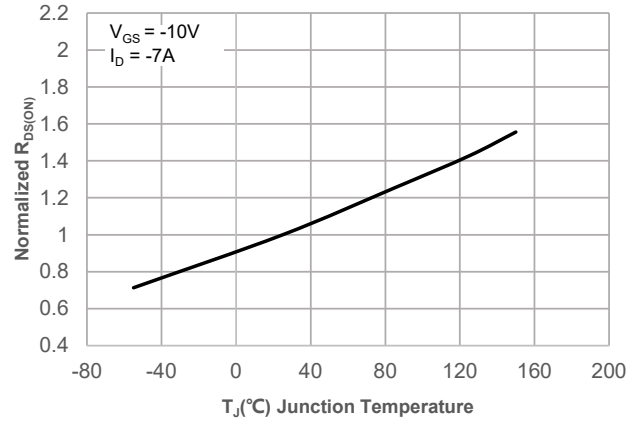

Figure 9: Maximum Safe Operating Area

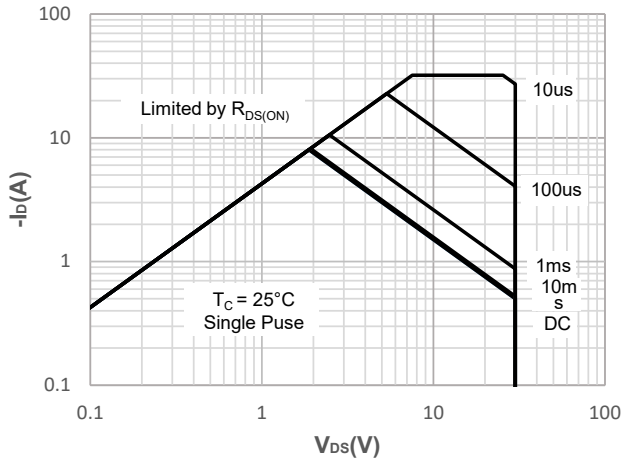

Figure 10: Maximum Continuous Driand Current vs. Case Temperature

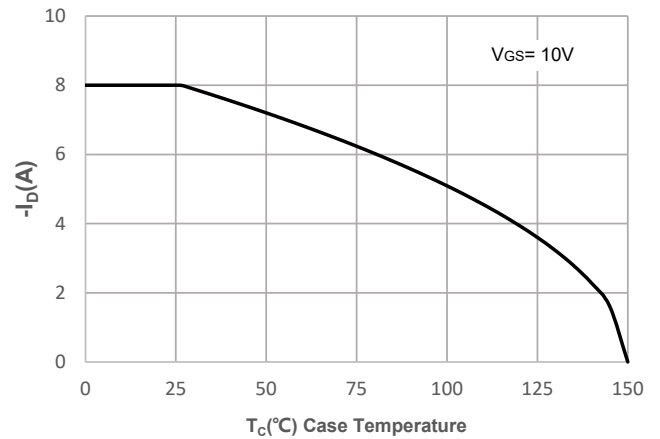

Figure 11: Normalized Maximum Transient Thermal Impedance

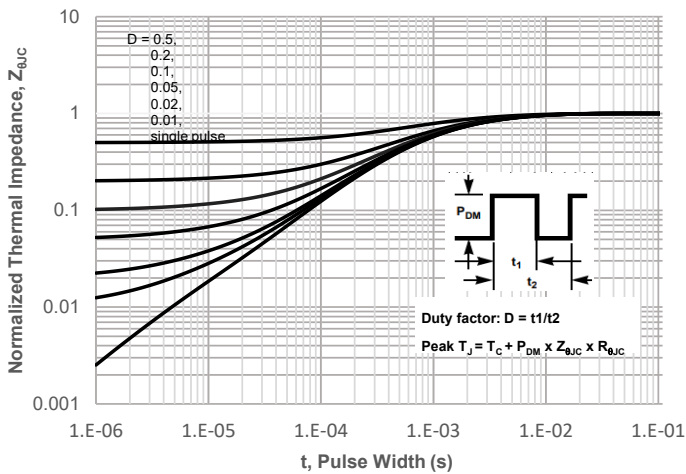
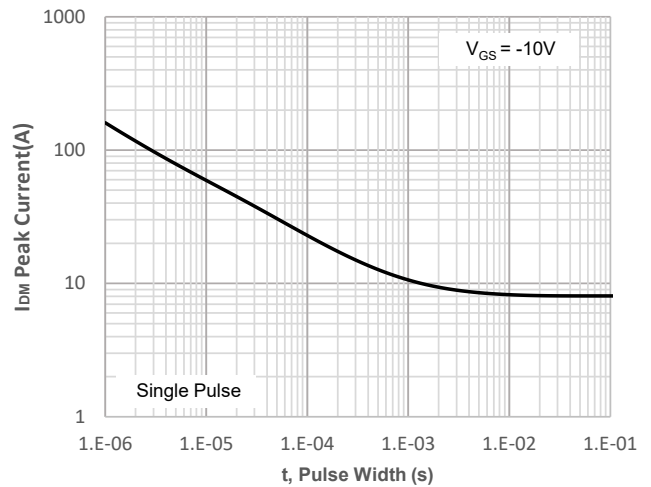

Figure 12: Peak Current Capacity





## Test Circuit-P

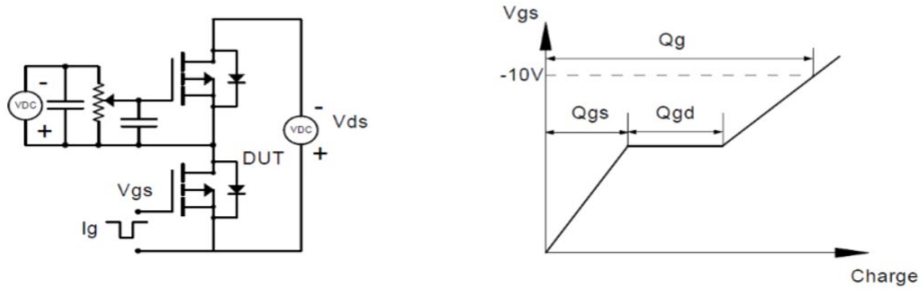

Figure 1: Gate Charge Test Circuit & Waveform

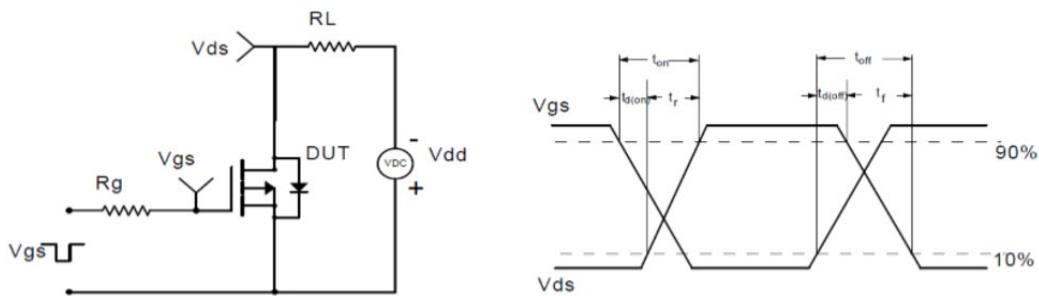

Figure 2: Resistive Switching Test Circuit & Waveform

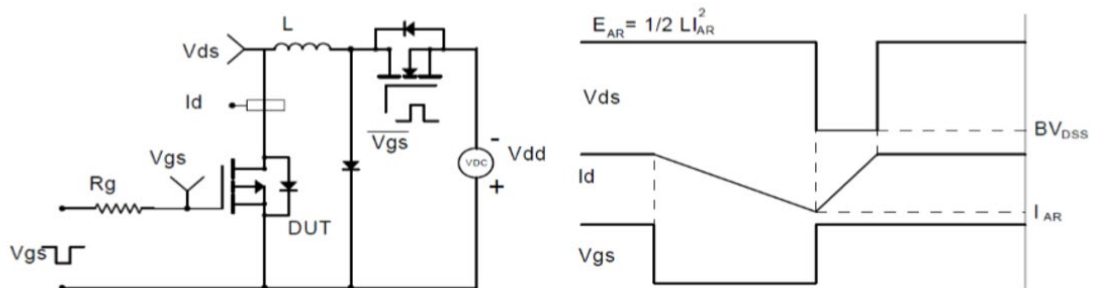

Figure 3: Unclamped Inductive Switching Test Circuit & Waveform

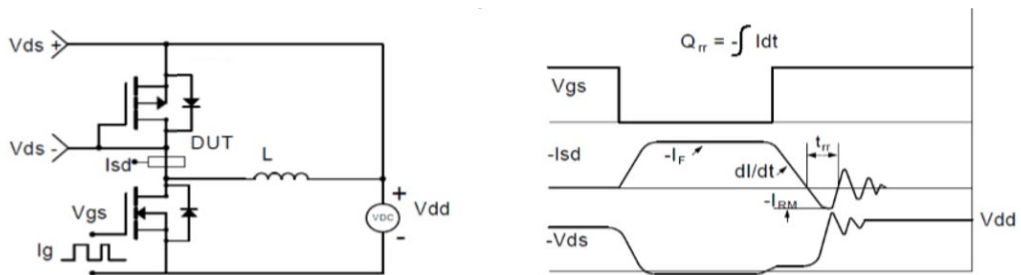
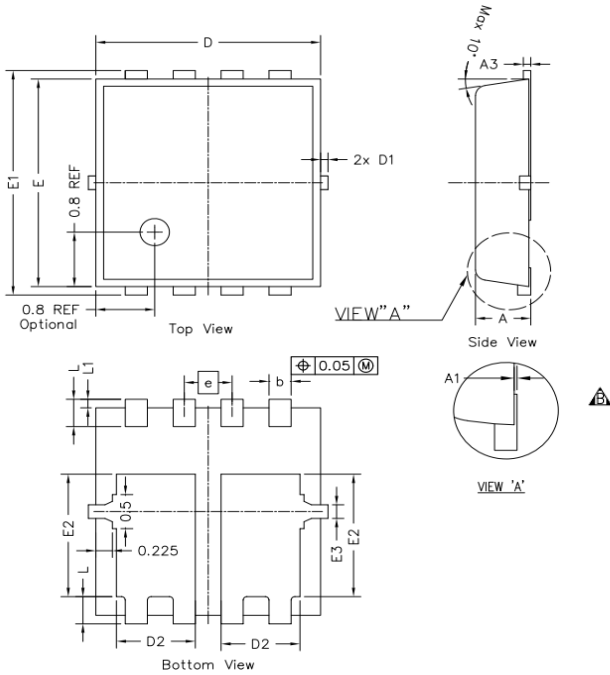

Figure 4: Diode Recovery Test Circuit & Waveform



## Package Mechanical Data(PDFN3x3-8L-D)



SYMBOLS	DIMENSION IN MM			DIMENSION IN INCHES		
	MIN	NOM	MAX	MIN	NOM	MAX
A	0.700	0.750	0.800	0.028	0.030	0.031
A1	---	---	0.050	----	----	0.002
A3	0.144	0.152	0.202	0.006	0.006	0.008
b	0.250	0.300	0.350	0.010	0.012	0.014
e	0.65 BSC			0.026 BSC		
D	2.950	3.050	3.150	0.116	0.120	0.124
E	2.950	3.050	3.150	0.116	0.120	0.124
D1	---	---	0.125	----	----	0.005
E1	3.200	3.300	3.400	0.126	0.130	0.134
D2	0.970	1.070	1.170	0.038	0.042	0.046
E2	1.700	1.800	1.900	0.067	0.071	0.075
E3	0.150	0.200	0.250	0.006	0.008	0.010
L	0.300	0.400	0.500	0.012	0.016	0.020
L1	0.075	0.125	0.175	0.003	0.005	0.007

Information furnished in this document is believed to be accurate and reliable. However, Jiangsu JieJie Microelectronics Co.,Ltd assumes no responsibility for the consequences of use without consideration for such information nor use beyond it. Information mentioned in this document is subject to change without notice, apart from that when an agreement is signed, Jiangsu JieJie complies with the agreement. Products and information provided in this document have no infringement of patents. Jiangsu JieJie assumes no responsibility for any infringement of other rights of third parties which may result from the use of such products and information.

 is a registered trademark of Jiangsu JieJie Microelectronics Co.,Ltd.  
 Copyright ©2023 Jiangsu JieJie Microelectronics Co.,Ltd. Printed All rights reserved.