

JORX213 Series

Rev.A.1.0

DESCRIPTION:

The JORX213 series combine an AlGaAs infrared emitting diode as the emitter which is optically coupled to a monolithic silicon zero-cross photo triac to drive a power triac in a plastic DIP7 package with different lead forming options. The products are widely used in solenoid/valve controls, lighting controls, motor controls, temperature controls, static AC power switches, solid state relays, interfacing microprocessors to 265 V_{AC} peripherals.

MAIN FEATURES:

- High isolation 5000 Vrms
- DC input with triac output
- Operating temperature range - 40°C to 85 °C
- REACH & RoHS compliance
- MSL class 2
- HBM: H3A; MM: M4
- CQC approved
- VDE approved
- UL approved

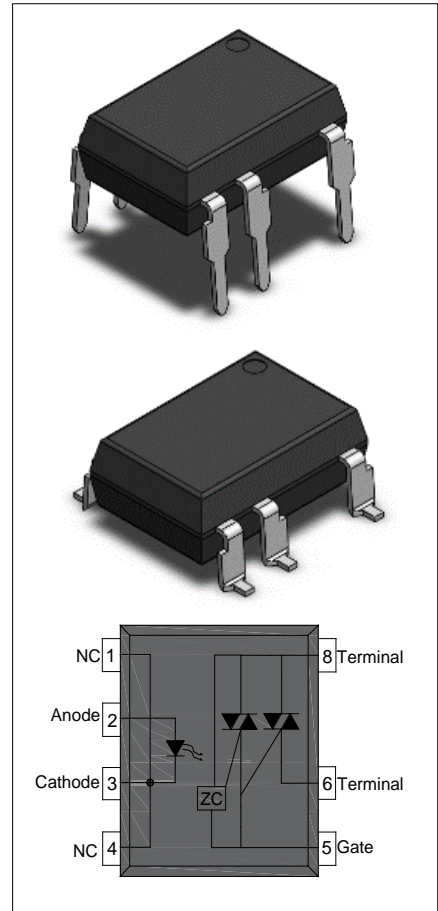

ABSOLUTE MAXIMUM RATINGS (Temperature=25°C)

Parameter		Symbol	Value	Unit	
Input	Forward Current	I_F	60	mA	
	Peak Forward Current	I_{FP}	1 ^①	A	
	Reverse Voltage	V_R	6	V	
Output	Repetitive peak off-state voltage	V_{DRM}	600	V	
	Repetitive peak off-state voltage	V_{RRM}	600	V	
	On-state RMS Current	JOR0213	$I_{T(RMS)}$	0.3	A
		JOR1213		0.6	
		JOR2213		0.9	
		JOR3213		1.2	
Non repetitive surge peak on-state current	JOR0213	I_{TSM}	3	A	
	JOR1213		6		

	(full cycle , $t_p=20ms$)	JOR2213		9	
		JOR3213		12	
Isolation Voltage		V_{iso}		5000 ^②	Vrms
Operating Temperature		T_{opr}		-40~85	°C
Storage Temperature		T_{stg}		-40~125	°C
Soldering Temperature		T_{sol}		260 ^③	°C

NOTE1 : 100μs pulse, 100Hzfrequency

NOTE2 : AC for 1minute, R.H.=40~60%

NOTE3 : For 10 seconds

ELECTRICAL CHARACTERISTICS (Temperature=25°C)

Parameter		Symbol	Condition	Min.	Typ.	Max.	Unit
Input	Forward Voltage	V_F	$I_F=20mA$	-	1.25	1.4	V
	Reverse Current	I_R	$V_R=6V$	-	-	1	μA
Output	Peak Off-state Current, Either Direction	I_{DRM}	$V_{DRM}/V_{RRM}=600V, I_F=0$	-	-	10	μA
		I_{RRM}		-	-	10	
	Peak On-state Voltage, Either Direction	V_{TM}	$I_{TM}=I_{TM}$ Rated	-	-	2	V
	Critical Rate of Rise of Off-state voltage	dV/dt	$V_D=400V,$ Gate Open $I_F=0,$ $T_j=85°C$	1000	-	-	V/μs
Transfer Characteristics	LED Trigger Current	I_{FT}	Terminal Voltage=6V $R_L=100Ω$	-	-	10	mA
	Holding Current	I_H	$V_D=6V$	-	-	25	mA
	Isolation Resistance	R_{ISO}	DC500V 40~60%R.H.	10^{12}	10^{14}	-	Ω
	Response Time	t_{on}	$V_D=6V,$ $R_L=100Ω,$ $I_F=20mA$	-	20	100	μs
Zero Crossing	Inhibit Voltage	V_{IH}	$I_F=10mA$	-	-	20	V
	Leakage in Inhibit State	I_{DRM2}	$I_F=10mA,$ $V_{OFF}=600V$	-	-	500	μA

ORDERING AND MARKING INFORMATION

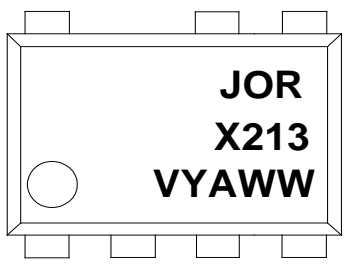
MARKING INFORMATION			
		<p>JOR : Company Abbr. X213 : Part Number & Rank V : VDE Option Y : Fiscal Year A : Manufacturing Code WW : Work Week</p>	
ORDERING INFORMATION			
JORX213(Y)(Z)-GV			
<p>JOR – Company Abbr. X213 – Part Number & Rank (X=0/1/2/3) Y – Lead Form Option (SL/None) Z – Tape and Reel Option (T1/T2) G – Green Option (G or None) V – VDE Option (V or None)</p>			
Packing Quantity			
Option	Quantity	Quantity – Inner box	Quantity –Outer box
None	50 Units/Tube	27 Tubes/Inner box	12 Inner box/Outer box =16.2k Units
SL(T1)	1000 Units/Reel	3 Reels/Inner box	5 Inner box/Outer box =15k Units
SL(T2)	1000 Units/Reel	3 Reels/Inner box	5 Inner box/Outer box =15k Units

Characteristics Curves

FIG.1: Forward Current vs. Ambient Temperature

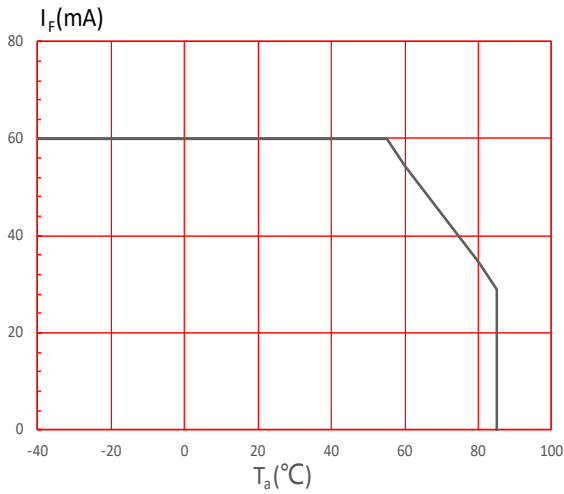

FIG.3: Forward Current vs. Forward Voltage

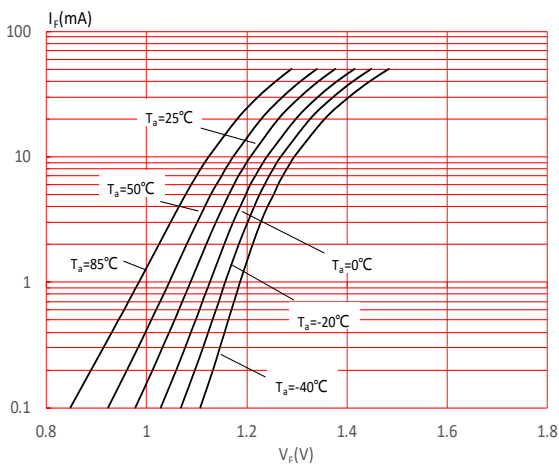

FIG.5: Off-state Terminal Current vs Off-state Terminal Voltage

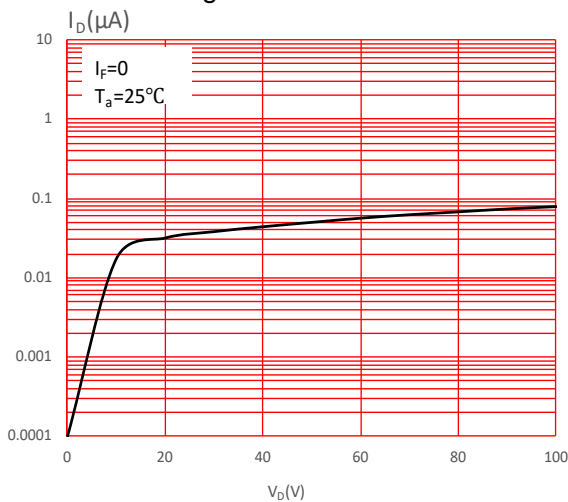

FIG.2: On-state Terminal Current vs. Ambient Temperature

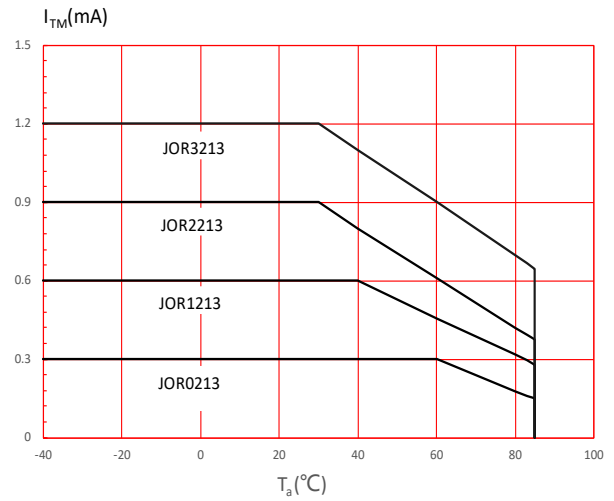

FIG.4: Forward Voltage vs. Ambient Temperature

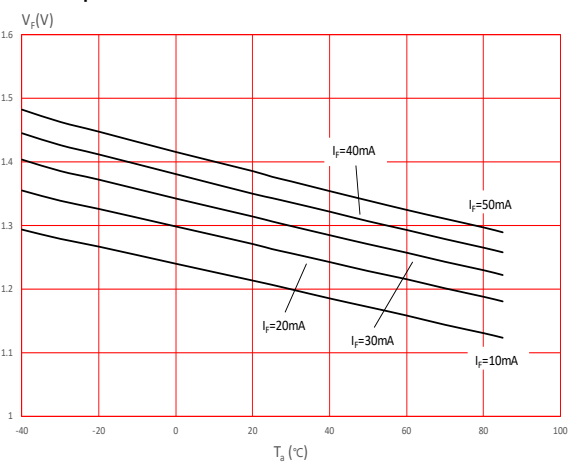

FIG.6: Normalized Trigger Current vs. Ambient Temperature

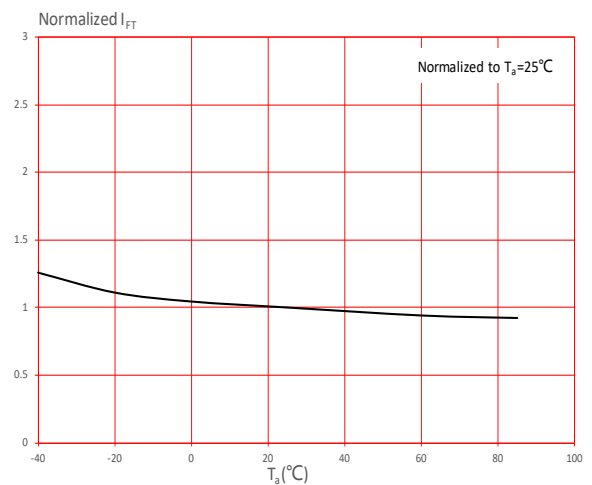

FIG.7: On-state Terminal Voltage vs. Ambient Temperature

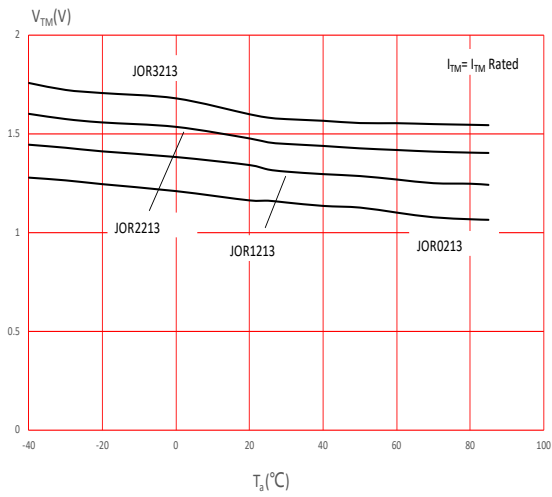

FIG.8: Normalized Holding Current vs. Ambient Temperature

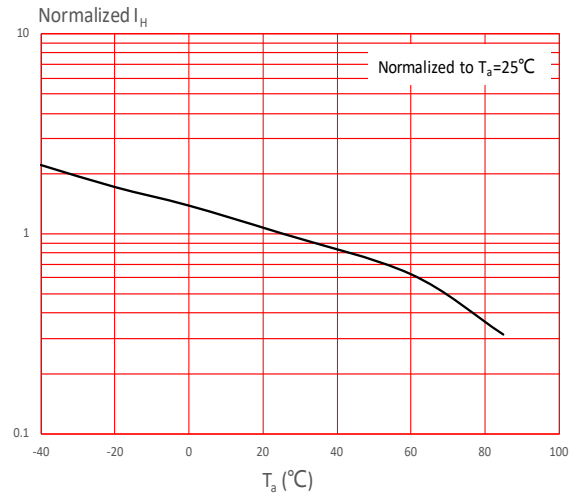

FIG.9: Turn On Time vs. Forward Current

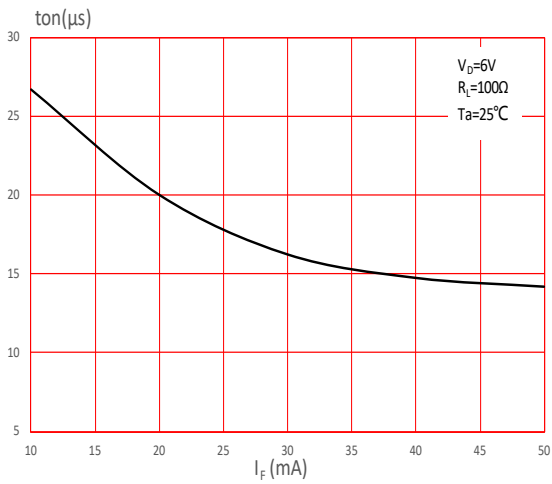
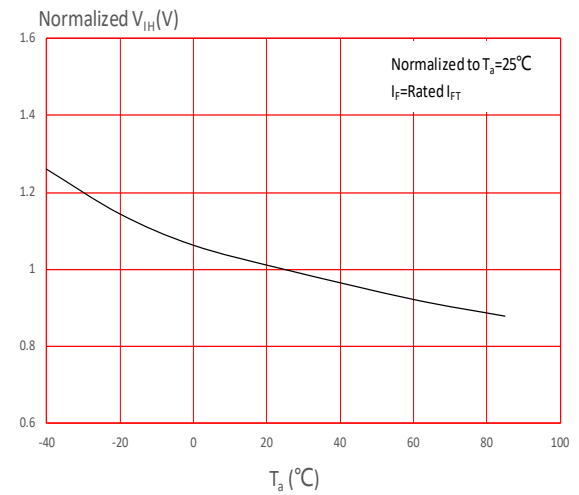

FIG.10: Normalized Inhibit Voltage vs. Ambient Temperature



TEST CIRCUITS

FIG.11: Test Circuits of Turn On Time

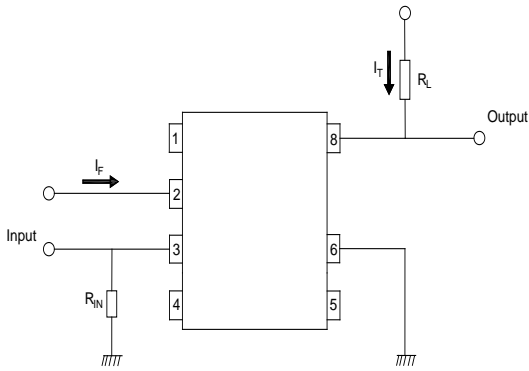
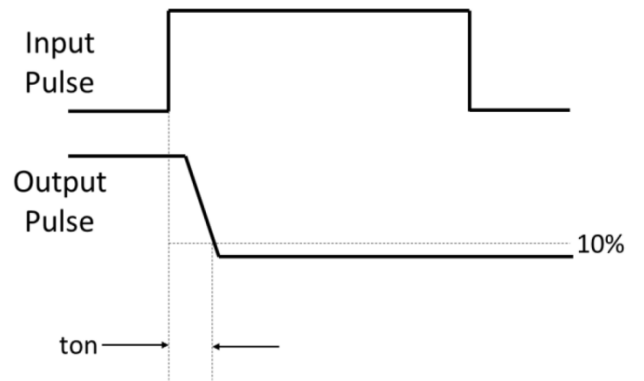
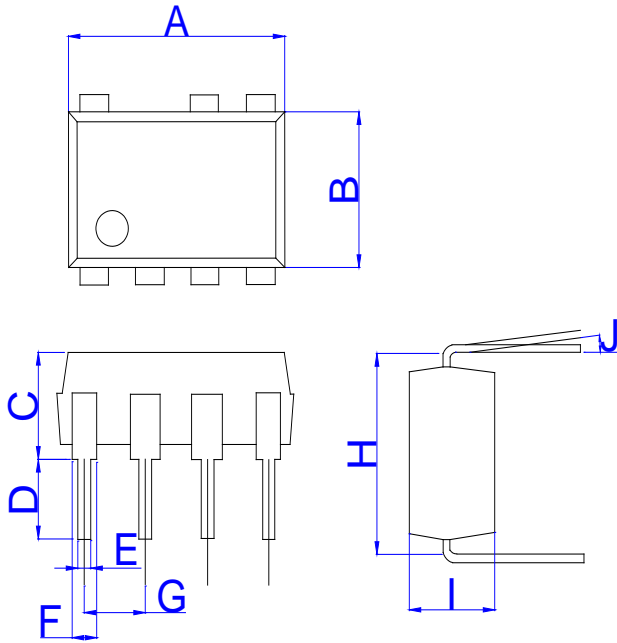

FIG.12: Waveforms of Turn On Time



Package Dimension (Unit: mm)

Standard DIP Type:



Ref.	Dimensions					
	Millimeters			Inches		
	Min.	Typ.	Max.	Min.	Typ.	Max.
A	9.68	9.78	9.88	0.381	0.385	0.389
B	6.30	6.40	6.50	0.248	0.252	0.256
C	3.70	3.90	4.10	0.146	0.154	0.162
D	2.90	3.00	3.10	0.114	0.118	0.122
E	0.40	0.50	0.60	0.016	0.020	0.024
F	1.10	1.20	1.30	0.043	0.047	0.051
G	2.44	2.54	2.64	0.096	0.100	0.104
H	7.52	7.62	7.72	0.296	0.300	0.304
I	3.30	3.40	3.50	0.130	0.134	0.138
J			10°			

Option SL Type:

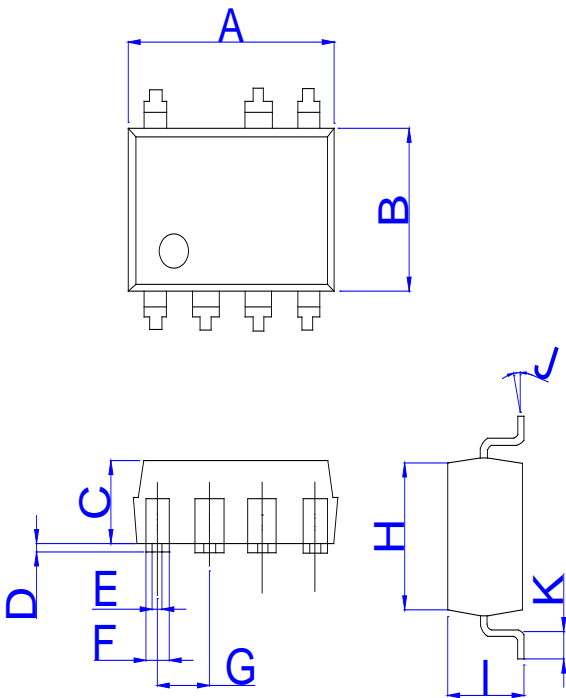

Ref.	Dimensions					
	Millimeters			Inches		
	Min.	Typ.	Max.	Min.	Typ.	Max.
A	9.68	9.78	9.88		0.385	
B	6.30	6.40	6.50		0.252	
C	3.30	3.40	3.50		0.134	
D		0.20	0.40		0.008	0.016
E	0.40	0.50	0.60	0.156	0.020	0.024
F	1.10	1.20	1.30	0.043	0.047	0.051
G	2.44	2.54	2.64	0.096	0.100	0.104
H	7.52	7.62	7.72	0.296	0.300	0.304
I	3.30	3.40	3.50	0.130	0.134	0.138
J			10°			
K	0.9	1.00	1.10	0.035	0.039	0.043

RECOMMENDED SOLDER MASK (Dimensions in mm unless otherwise stated)

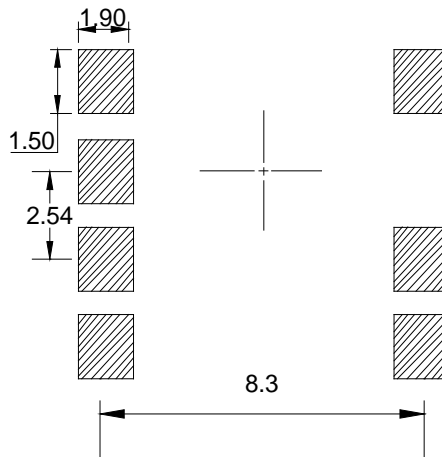

CARRIER TAPE SPECIFICATIONS (Dimensions in mm unless otherwise stated)

Option SL(T1)

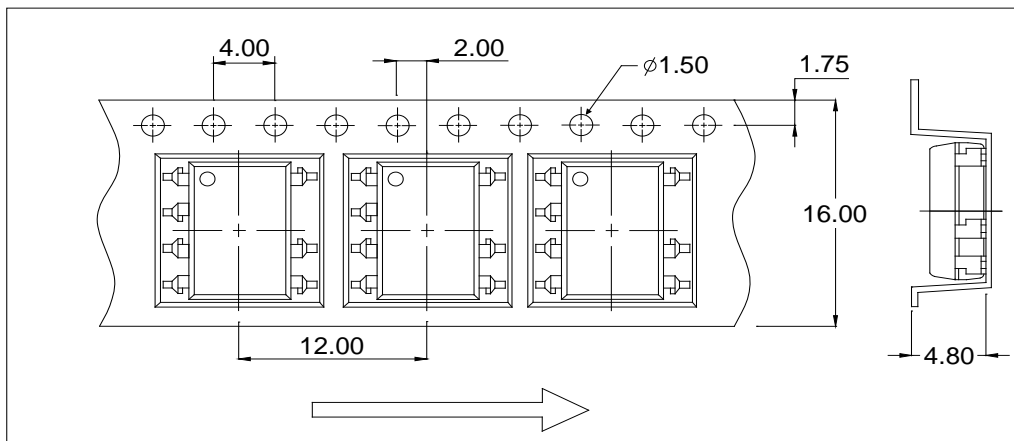

Option SL(T2)

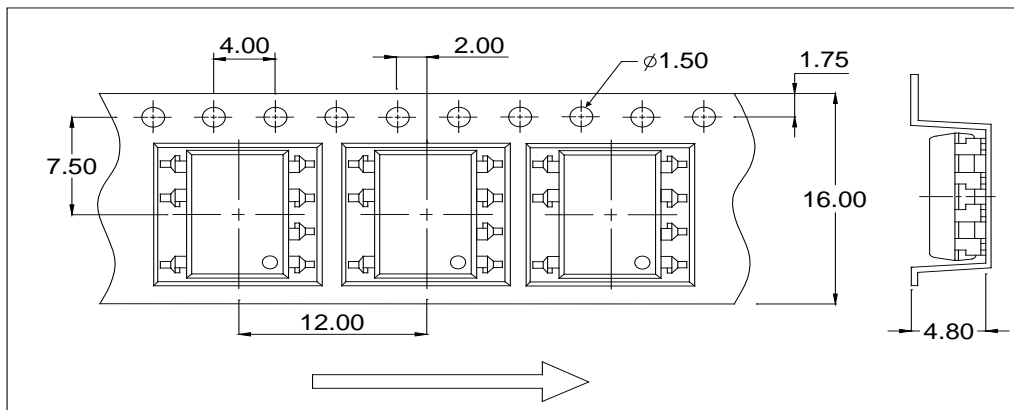

REFLOW INFORMATION

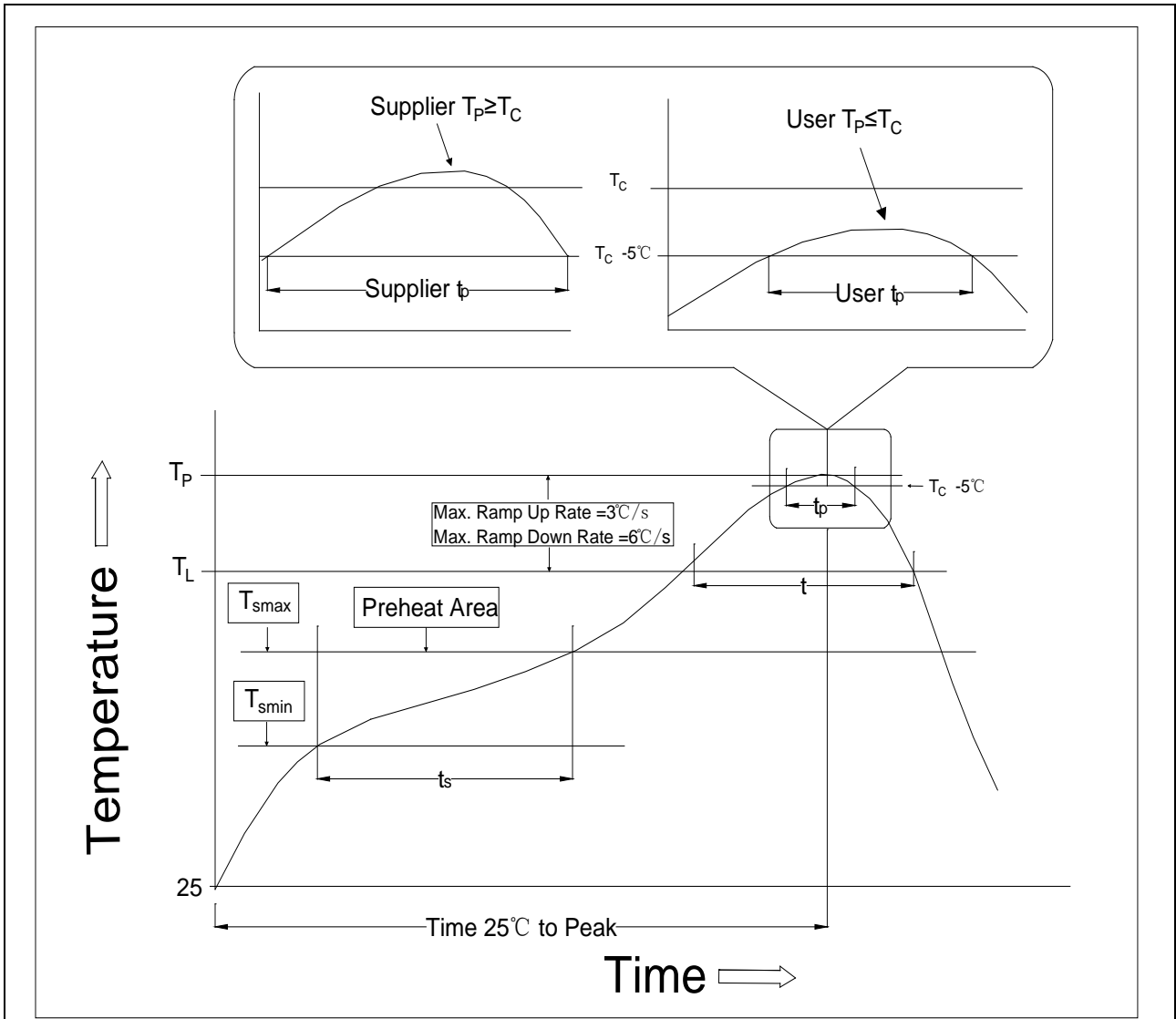

Temperature Min. (T _{smin})	150 °C
Temperature Max. (T _{smax})	200 °C
Time (t _s) from (T _{smin} to T _{smax})	60-120 seconds
Ramp-up Rate (t _L to t _P)	3°C/second max.
Liquidous Temperature (T _L)	217 °C
Time (t _L) Maintained Above (T _L)	60-120 seconds
Peak Body Package Temperature	260 °C +0 °C / -5 °C
Time (t _P) within 5 °C of 260 °C	10 seconds
Ramp-down Rate (T _P to T _L)	6°C/second max.

Information furnished in this document is believed to be accurate and reliable. However, Jiangsu JieJie Microelectronics Co., Ltd. assumes no responsibility for the consequences of use without consideration for such information nor use beyond it. Information mentioned in this document is subject to change without notice, apart from that when an agreement is signed, Jiangsu JieJie complies with the agreement.

Products and information provided in this document have no infringement of patents. Jiangsu JieJie assumes no responsibility for any infringement of other rights of third parties which may result from the use of such products and information. This document supersedes and replaces all information previously supplied.

 is a registered trademark of Jiangsu JieJie Microelectronics Co., Ltd.
Copyright © 2025 Jiangsu JieJie Microelectronics Co., Ltd. All rights reserved.